

# B 748C

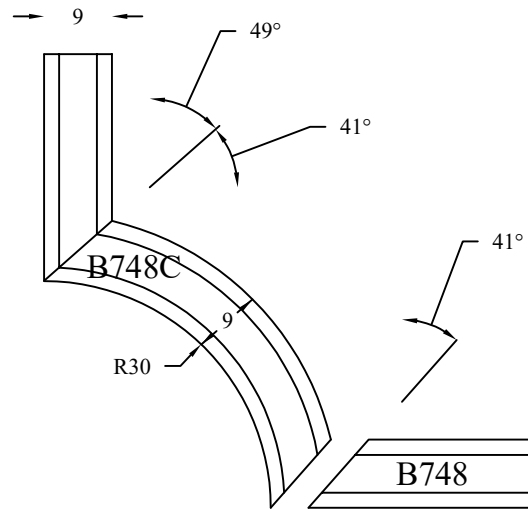

## Fitment Notes:

1. Curve supplied pre-cut at 49° angle
2. Straight needs to be cut at 41° angle
3. Curve comes at 9mm width in order to match the profile of the straight.

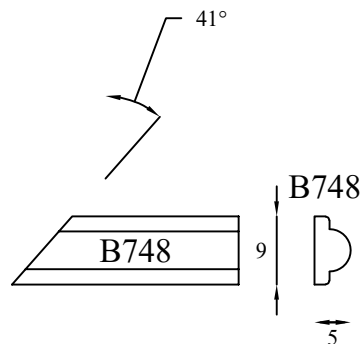

Straight needs to be cut at 41° angle